

**OFICIUL DE STAT PENTRU INVENȚII
ȘI MĂRCI BUCUREȘTI ROMÂNIA**

**CERERI DE ÎNREGISTRARE A
DESENELOR ȘI MODELELOR**

PUBLICATE ÎN

DATA DE 04/07/2019

**CLASA 09 - AMBALAJE ȘI RECIPIENȚI
PENTRU TRANSPORTUL SAU PĂSTRAREA
MĂRFURILOR**

(21) **f 2019 0126**; (22) 01/07/2019; (43) 04/07/2019;
(71) **S.C. EPOMARK TRADE S.R.L.**, STR. GĂRII
NR.1, GURAHONT, AR 317145, ARAD, ROMANIA;
(72) CĂTĂLIN MICULA, STR. JEAN STERIADI NR.
20, BL. 121, SC.C, AP. 36, BUCUREȘTI, 032501,
ROMANIA; (54) **BUTELIE PET, STICLĂ**; (28) 1; (51)
09-01;



(21) f 2019 0126-1.1

(21) **f 2019 0099**; (22) 03/06/2019; (43) 04/07/2019;
(71) **S.C. ROYAL ESTATES & BUILDING S.R.L.**,
STR. IOSIF VULCAN NR. 5, AP. 17, ORADEA,
410041, BIHOR, ROMANIA; (72) ; (54) **BUTELIE
PET**; (28) 1; (51) 09-01;

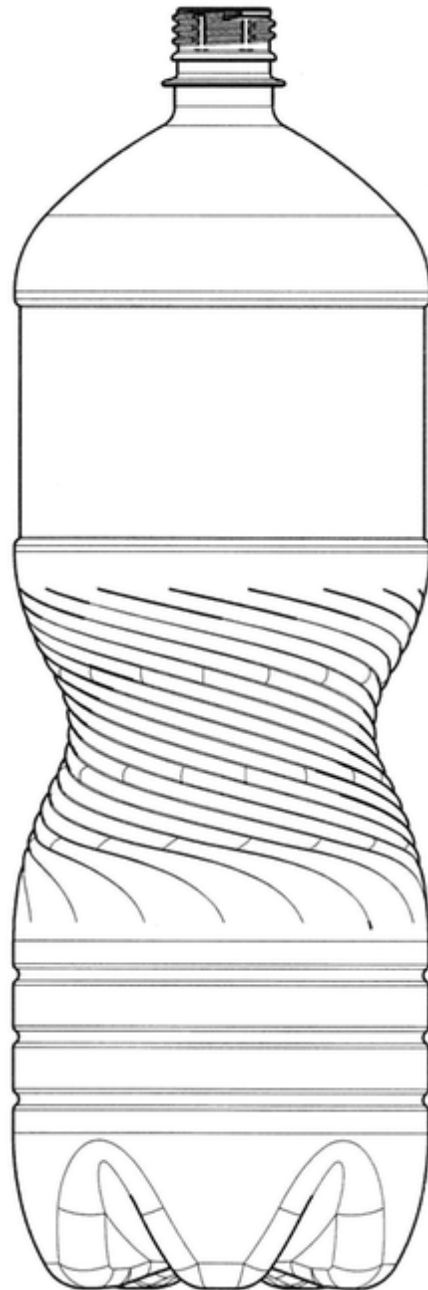

(21) f 2019 0099-1.1

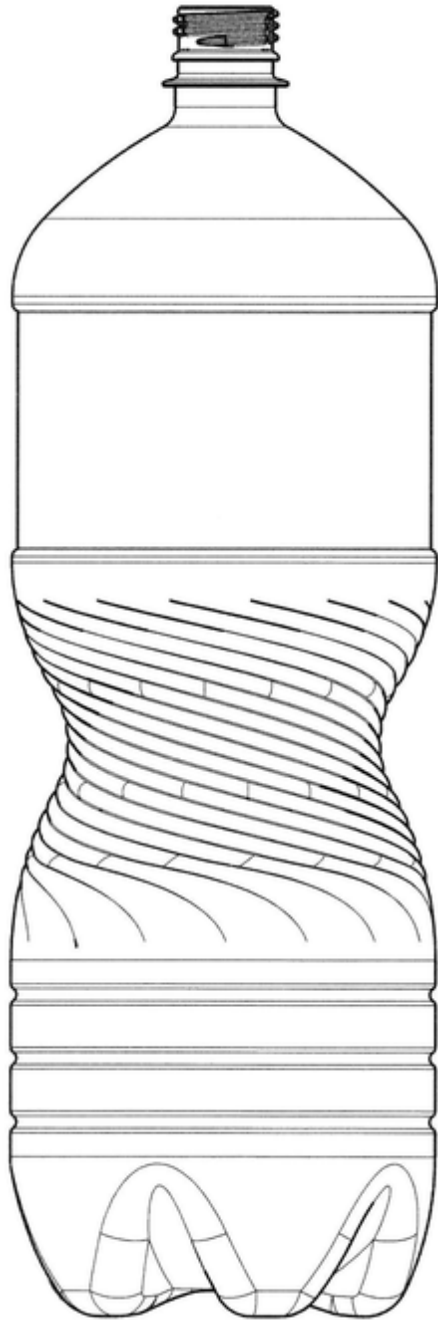

(21) f 2019 0099-1.2

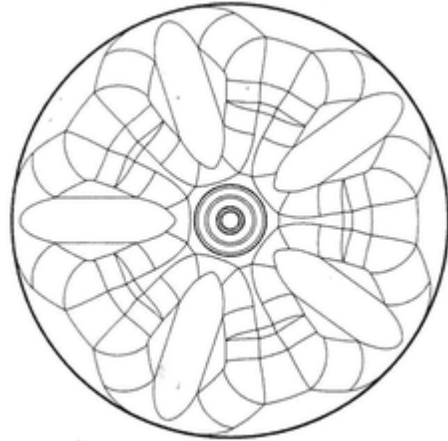

(21) f 2019 0099-1.3

(21) f 2019 0100; (22) 03/06/2019; (43) 04/07/2019;
(71) **S.C. ROYAL ESTATES & BUILDING S.R.L.**,
STR. IOSIF VULCAN NR. 5, AP. 17, ORADEA,
410041, BIHOR, ROMANIA; (72) ; (54) **BUTELIE
PET**; (28) 1; (51) 09-01;



(21) f 2019 0100-1.1



(21) f 2019 0100-1.2

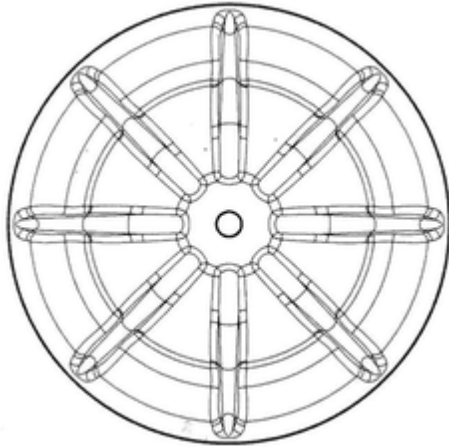

(21) f 2019 0100-1.3

(21) f 2019 0101; (22) 03/06/2019; (43) 04/07/2019;
(71) **S.C. ROYAL ESTATES & BUILDING S.R.L.**,
STR. IOSIF VULCAN NR. 5, AP. 17, ORADEA,
410041, BIHOR, ROMANIA; (72) ; (54) **BUTELIE
PET**; (28) 1; (51) 09-01;

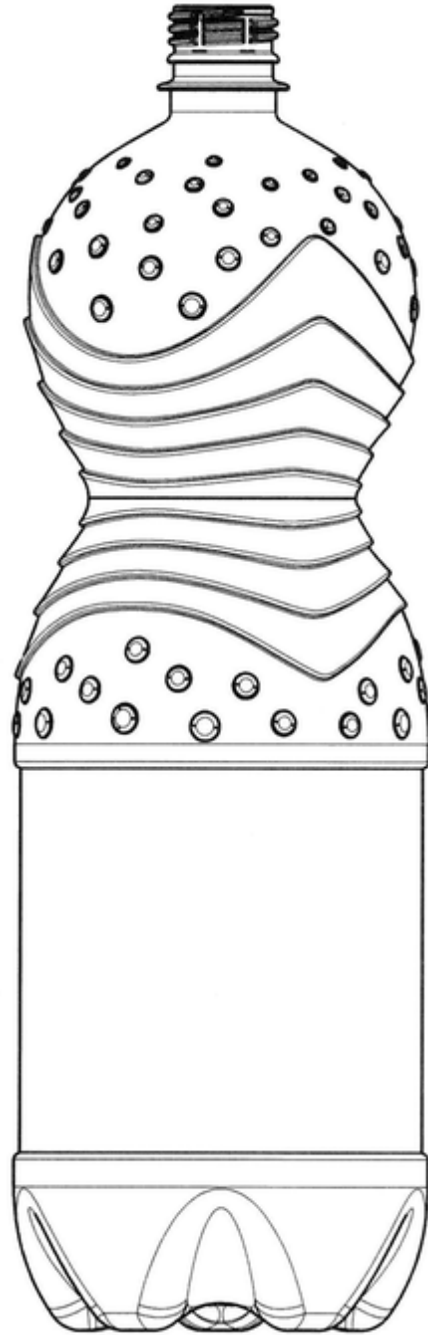

(21) f 2019 0101-1.1

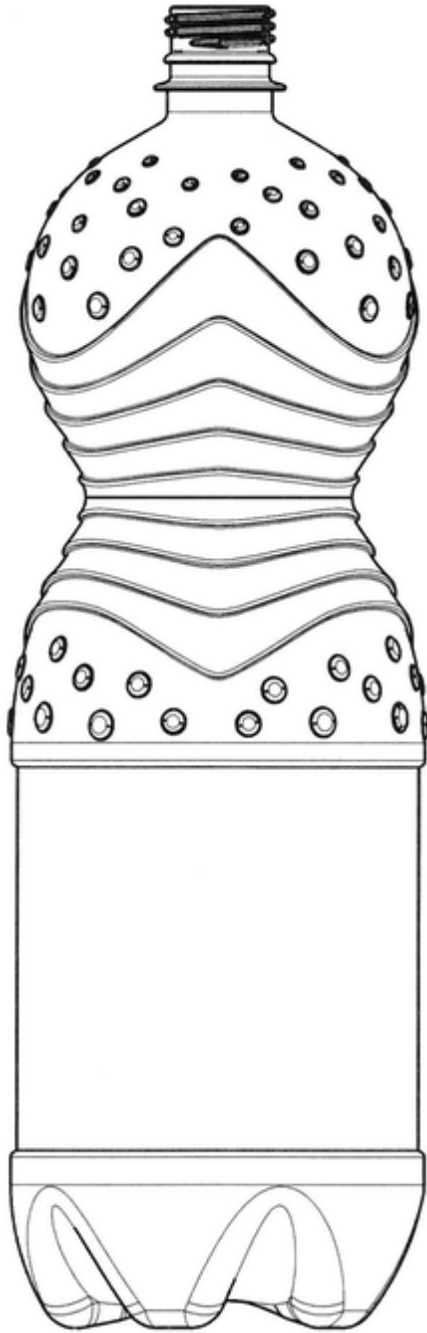

(21) f 2019 0101-1.2

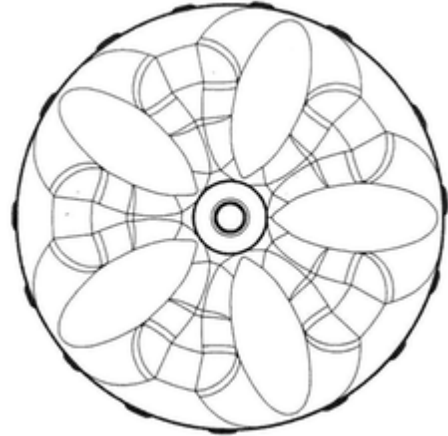

(21) f 2019 0101-1.3

(21) f 2019 0102; (22) 03/06/2019; (43) 04/07/2019;
(71) **S.C. ROYAL ESTATES & BUILDING S.R.L.**,
STR. IOSIF VULCAN NR. 5, AP. 17, ORADEA,
410041, BIHOR, ROMANIA; (72) ; (54) **BUTELIE
PET**; (28) 1; (51) 09-01;

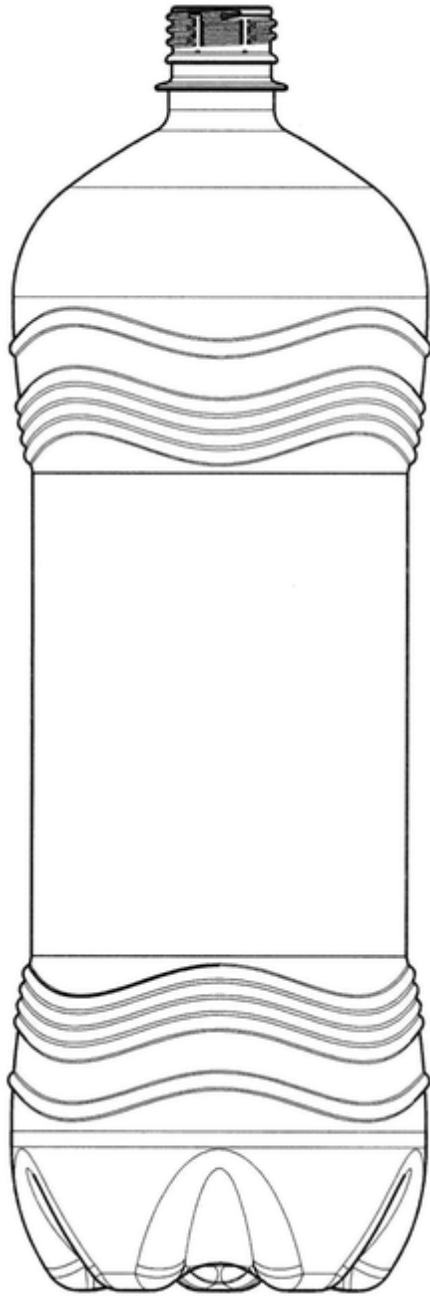

(21) f 2019 0102-1.1

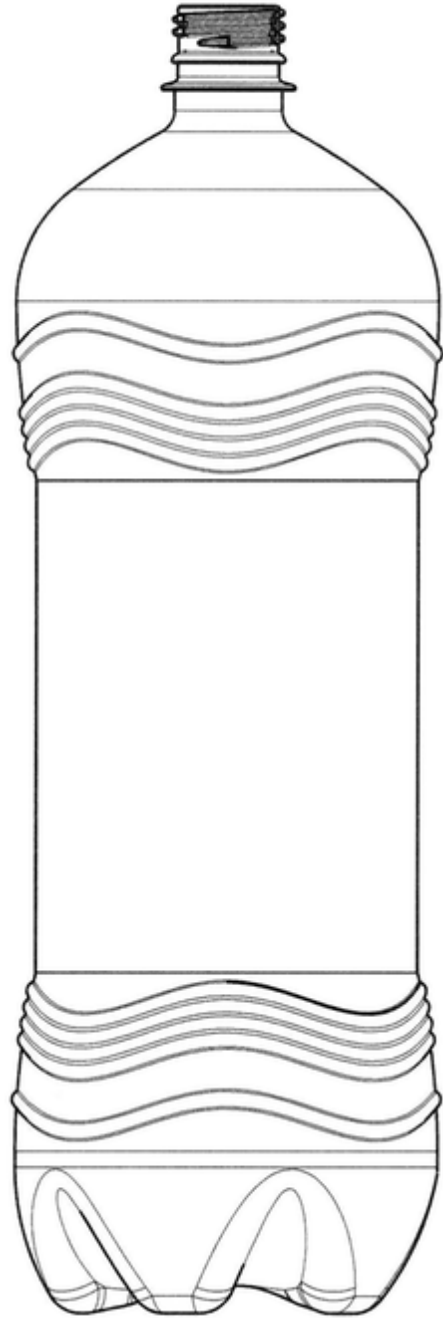

(21) f 2019 0102-1.2

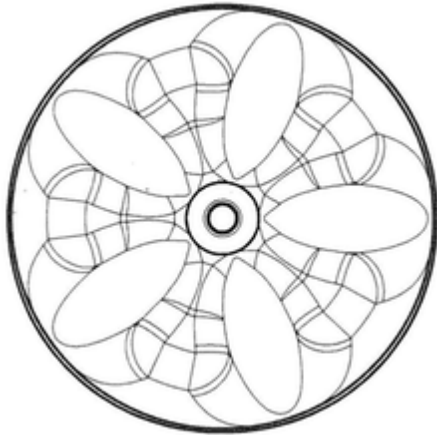

(21) f 2019 0102-1.3

(21) f 2019 0103; (22) 03/06/2019; (43) 04/07/2019;
(71) **S.C. ROYAL ESTATES & BUILDING S.R.L.**,
STR. IOSIF VULCAN NR. 5, AP. 17, ORADEA,
410041, BIHOR, ROMANIA; (72) ; (54) **BUTELIE
PET**; (28) 1; (51) 09-01;

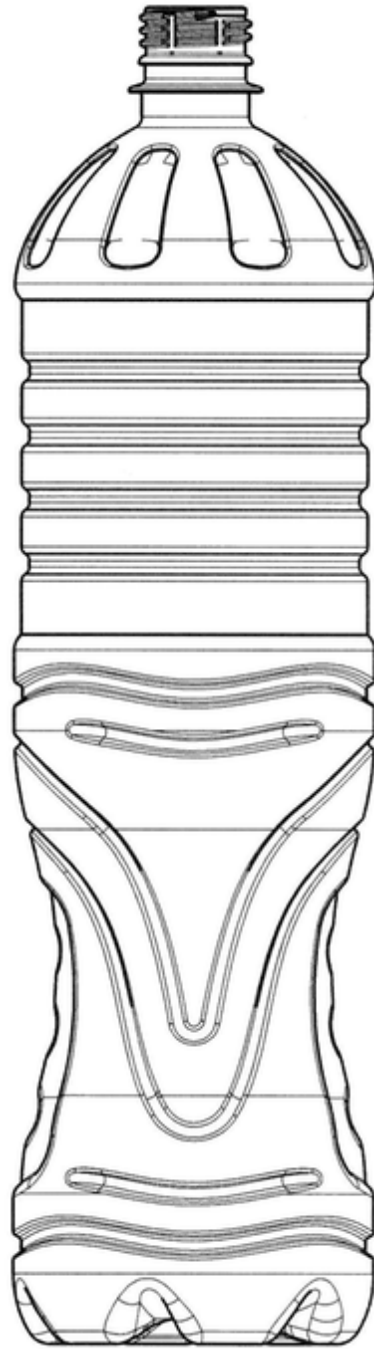

(21) f 2019 0103-1.1

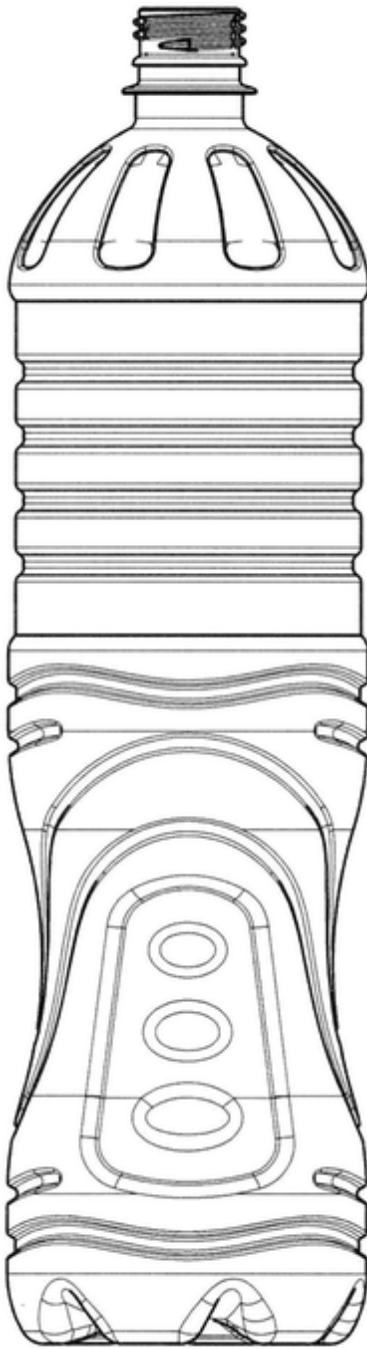

(21) f 2019 0103-1.2

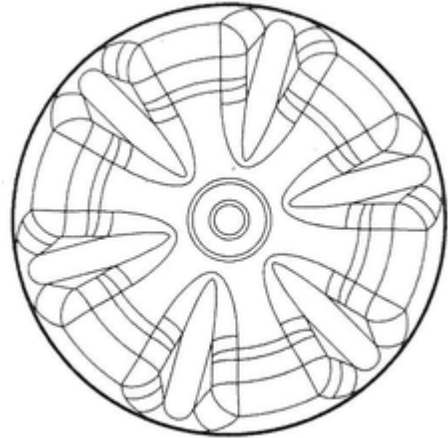

(21) f 2019 0103-1.3

(21) f 2019 0104; (22) 03/06/2019; (43) 04/07/2019;
(71) **S.C. ROYAL ESTATES & BUILDING S.R.L.**,
STR. IOSIF VULCAN NR. 5, AP. 17, ORADEA,
410041, BIHOR, ROMANIA; (72) ; (54) **BUTELIE
PET**; (28) 1; (51) 09-01;

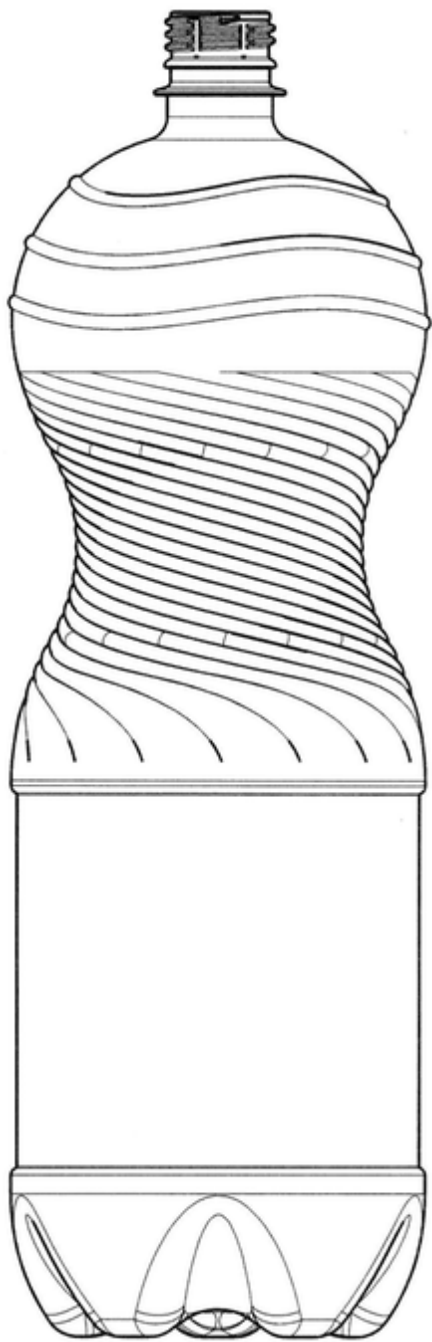

(21) f 2019 0104-1.1

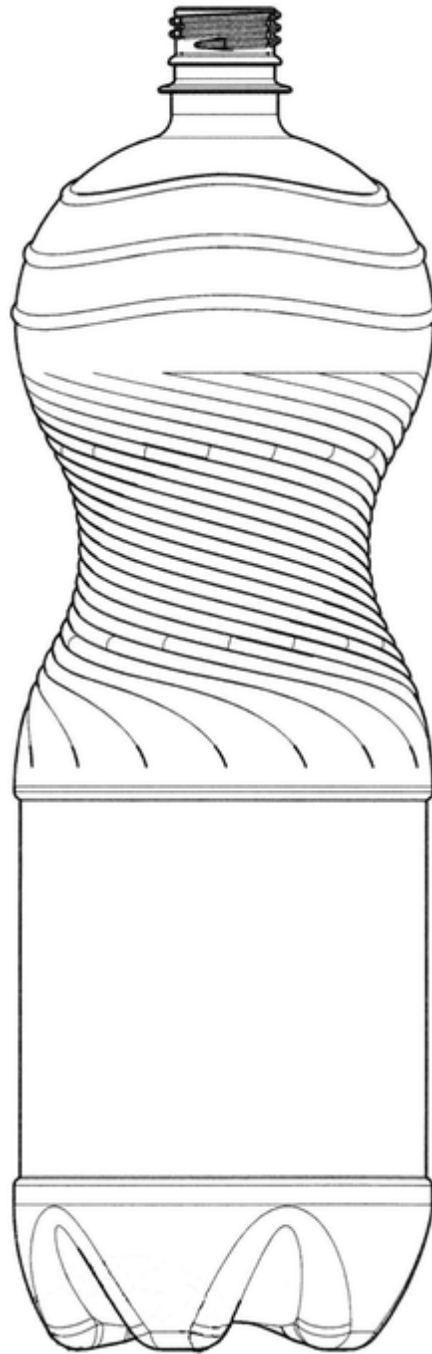

(21) f 2019 0104-1.2

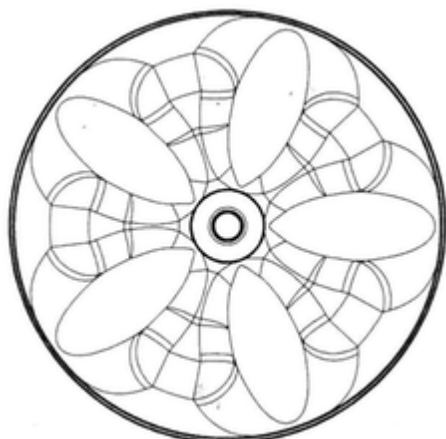

(21) f 2019 0104-1.3



(21) f 2019 0125-1.2

**CLASA 19 - PAPETĂRIE, ARTICOLE DE BIROU,
MATERIALE PENTRU ARTE ȘI PENTRU
ÎNVĂȚĂMÂNT**

(21) f 2019 0125; (22) 28/06/2019; (43) 04/07/2019;
(71) **BANCA NAȚIONALĂ A ROMÂNIEI**, STR.
LIPSCANI NR. 25, SECTOR 3, BUCUREȘTI,
030031, BUCUREȘTI, ROMANIA; (72) ROBITU
MIHAI, STR. BAȚIȘTE, NR.30, SECTORUL 2,
BUCUREȘTI, 020938, BUCUREȘTI, ROMANIA; (54)
**MONEDE NUMISMATICE CU VALORI NOMINALE
DE 100 LEI, 10 LEI ȘI 1 LEU CU TEMA
DESĂVÂRȘIREA MARIÍ UNIRI - ALEXANDRU
MARGHILOMAN**; (28) 3; (51) 19-99;



(21) f 2019 0125-2.1



(21) f 2019 0125-1.1



(21) f 2019 0125-3.1

CLASA 26 - APARATE DE ILUMINAT

(21) f 2019 0123; (22) 18/12/2018; (43) 04/07/2019;
(71) **RENAULT SAS**, 13/15 QUAI LE GALLO,
BOULOGNE BILLANCOURT, F-92100, FRANȚA;
(72) PIERRE SABAS, 13/15 QUAI LE GALLO,
BOULOGNE - BILLANCOURT, 92100, FRANȚA;
(54) **DISPOZITIVE LUMINOASE**; (28) 7; (51) 26-06;
(80) DM/200 128 / 18/12/2018 / 28/06/2019;

(21) **f 2019 0124**; (22) 30/11/2018; (43) 04/07/2019; (71) **LOGISTICS COMMAND OF NAȚIONAL ARMED FORCES OF THE REPUBLIC OF LATVIA**, VIENIBAS ALLEY 56, RIGA, LETONIA; (72) MAREKS HOFMANIS, BLAUMANA IELA 9, RIGA, LV-1011, LETONIAAGRIS NIKITENKO, STOPINU NOVADS, LICĪ, LV- 2118, LETONIAARNIS PAEGLITIS, HOSTITĀLU IELA 38A-43, RIGA, LV-1013, LETONIAKRISTIANS BREDERMANIS, IRLAVAS IELA 12-44, RIGA, LV-1046, LETONIAJURIS ULMANIS, ELIZABETES IELA 23A-17, RIGA, LV-1010, LETONIAMARTINS PAEGLITIS, HOSTITĀLU IELA 38A-43 , RIGA, LV-1013 , LETONIAJURIS KIPLOKS, KURMALES IELA 3, RIGA, LV-1058, LETONIA; (54) **MOTIV DECORATIV**; (28) 1; (51) 32-00; (80) DM/201 636 / 30/11/2018 / 28/06/2019;
